



# EVE Energy Co., Ltd

## Product Specification

File No: LF280N-72174

Version: A

Effective Date: 2019-12-22

Product:	LFP Power Battery
Model:	LF280N
Specification:	3.2V/280Ah
Draft:	<u>余天波 2019.12.21</u>
Checked:	<u>王华 2019.12.22</u>
Approved:	<u>范丁丁 2019.12.22</u>
Customer Approval:	_____

Mail: [sales@evebattery.com](mailto:sales@evebattery.com)

Address: No.68, Jingnan Avenue High-Tech Zone, Duodao District, Jingmen, Hubei



## Contents

1	Scope.....	1
2	Description and Model .....	1
3	标称技术参数 General Technical Parameter .....	1
4	测试条件 Test Conditions .....	2
5	电池性能 Main Performance .....	2
6	运输 Transportation.....	4
7	贮存 Storage.....	5
8	注意事项 Precautions.....	5
	附录一: 电池二维图 Appendix I: 2D battery diagram .....	5
	附录二: 电池刻码规则 Appendix II: Battery coding rules.....	6
	附录三: 电池外观照片 Appendix III: Battery appearance picture.....	6
	附录四: 电池包装图 Appendix IV: Battery Packing Diagram .....	7
	附录五: 电性能曲线图 Appendix V: Battery performance graph .....	7

## 1 Scope

This specification is applied to Rechargeable LFP Power Battery with aluminum shell manufactured by EVE Energy Co., Ltd., in which the description and model, main performance, test conditions and precautions of the product are included.

The product can be applied for Vehicle power supply, Storage system, etc.

## 2 Description and Model

**2.1 Description:** LFP Li-ion Power Battery with aluminum shell.

**2.2 Model:** LF280N.

## 3 General Technical Parameter

No.	Item		Parameter	Remark
1	Typical Capacity		280Ah	(25±2)°C, Standard charge and discharge
2	Typical Voltage		3.2V	
3	AC Impedance Resistance		≤0.25mΩ	
4	Standard charge and discharge	Charge/Discharge Current	0.5C/0.5C	(25±2)°C
		Charge/Discharge Cut-off Voltage	3.65V/2.5V	
5	Max Charge/Discharge Current	Continuous Charge/Discharge Current	1C/1C	Reference Continuous/Pulse Charge/Discharge Current Map
		Pulse Charge/Discharge Ccurrent (30s)	2C/2C	
6	Recommended SOC window		10%~90%	N.A.
7	Charging Working Temperature		0°C~60°C	Reference Continuous/Pulse Charge/Discharge Current Map
8	Discharging Working Temperature		-30°C~60°C	
9	Storage Temperature	Short Term(Within a Month)	-20°C~45°C	N.A.

		Long Term(Within a Year)	0°C~35°C	
10	Storage Humidity		<95%	
11	Monthly Self-discharge Rate		≤3%/M	(25±2)°C, Storage SOC 30%~50%SOC
12	Dimension	Width	173.7±0.3mm	Reference Appendix I
13		Thickness(300±20kgf, 40%SOC)	71.5±0.5mm	
14		High(total)	204.8±0.5mm	
15		High(subject)	200.2±0.5mm	
16		Tab Distance	90.0±0.3mm	
17	Weight		5.30±0.3kg	

## 4 Test Conditions

### 4.1 Test Environmental conditions

Temperature: (25±2) °C

Relative Humidity: 15%~85%

Atmospheric Pressure: 86KPa~106KPa

### 4.2 Standard Charge

The standard charge means charging the cell with charge current 0.5CA and constant voltage 3.65V at (25±2)°C, 0.05C cut off.

### 4.3 Standard Discharge

The standard discharge means discharging the cell with discharge current 0.5CA and cutoff voltage 2.5V at (25±2) °C. If required, the battery can be discharged at 1.0CA constant current to a cutoff voltage of 2.5V.

## 5 Main Performance

### 5.1 Electrical performance

No.	Item	Requiments	Measuring Procedure
1	C-Rate DisCharge Performance at 25°C	Discharge Capacity/ Typical Capacity × 100% A) 0.5C(A) ≥ 100% B) 1.0C(A) ≥ 100%	After standard charge and 1h rest, discharge to 2.5V cutoff with the current of 0.33C(A), 0.5C(A), 1C(A) respectively. Repeating 3 times, if the capacity is not qualified.
2	Discharge performance at different temperatures	Discharge Capacity/ Typical Capacity × 100% A) 55°C时 ≥ 95% B) -20°C时 ≥ 70%	A) After standard charge and 5h rest at 55 ± 2°C, discharge to 2.5V cutoff with the current of 1.0C(A); B) After standard charge and 24h rest at -20 ± 2°C, discharge to 2.0V cutoff with the current of 1.0C(A);
3	Charge Retention and Recovery at 25°C	Remaining Capacity ≥ Typical Capacity × 95% Recovery Capacity ≥ Typical Capacity × 97%	After standard charge and open the circuit for 28 days at 25°C, discharge to 2.5V cutoff with the current of 1.0C(A), recorded as remaining capacity; After standard charged and 30mins rest, discharge current 1.0CA with 2.5V cut-off at (25 ± 2) °C, recorded as Recovery Capacity.
4	Cycle Life at 25°C	≥ 3500 cycles @ 1C/1C	At 25 ± 2°C, the battery under 300kgf fixture: charging the cell with charge current 1.0C(A) and constant voltage 3.65V, 0.05C cut off, rest for 30min, discharge to 2.5V cut off with the current of 1.0C(A), rest for 30min, and then start the next cycle, end with the capacity decrease to 80% of the initial capacity. The number of cycles is defined as the cycle life of the battery
5	Cycle Life at 45°C	≥ 1800 cycles @ 1C/1C	At 45 ± 2°C, the battery under 300kgf fixture: charging the cell with charge current 1.0C(A) and constant voltage 3.65V, 0.05C cut off, rest for 30min, discharge to 2.5V cut off with the current of 1.0C(A), rest for 30min, and then start the next cycle, end with the capacity

			decrease to 80% of the initial capacity. The number of cycles is defined as the cycle life of the battery
6	End of Life Management	Capacity/Typical Capacity <70%	During the use of the battery, when the end of life is exceeded, should stop use the battery.

## 5.2 Safety performance

No.	Item	Requirements	Measuring Procedure
1	Over Discharging	No explosion, No fire, No leakage	Reference: GB/T 31485-2015 <《Safety requirements and test methods for traction battery of electric vehicle》>
2	Over charging	No explosion, No fire	
3	Short circuit Test	No explosion, No fire	
4	Drop Test	No explosion, No fire, No leakage	
5	Heating	No explosion, No fire	
6	Extrusion Test	No explosion, No fire	
7	Seawater immersion	No explosion, No fire	
8	Temperature cycling	No explosion, No fire, No leakage	
9	Low pressure	No explosion, No fire, No leakage	
10	Thermal runaway	No explosion, No fire	Reference: 《Technical specifications for electric bus safety》

## 6 Transportation

Battery for shipping should be packed in boxes with the condition of half charged (30%~50%SOC). The Violent vibration, impact extrusion, sun and rain should be prevented during

shipping. The battery is suitable for cars, trains, ships, aircraft and other transportation vehicles.

## 7 Storage

Batteries should be stored (more than 1 month) indoor with a dry and clean environment at 0°C ~35°C. Avoiding contact with corrosive substances and staying away from fire and heat source. The battery should be charged and discharged every 6 months. The storage SOC is between 30 ~ 50% .

## 8 Precautions

- 1、 When charging and discharging the battery, ensure that the battery voltage, current and temperature are monitored and protected.
- 2、 Keep the battery away from heat sources, fire sources, and other corrosive environments such as heat and strong acids and alkalis.
- 3、 Do not short the battery or install it with incorrect polarity at any time
- 4、 Do not mix batteries of different models or different manufacturers.
- 5、 Do not use external force to drop, impact or puncture the battery, do not disassemble the battery or change the external structure
- 6、 When the battery is not used for a long time, please keep the battery charge at 30% ~ 50% SOC, and avoid direct sunlight or high temperature and high humidity environment.
- 7、 When operating the battery, you need to wear protective equipment such as rubber gloves
- 8、 If the battery leaks, smokes or is damaged, please stop using it immediately and contact us.

### Appendix I: 2D battery diagram

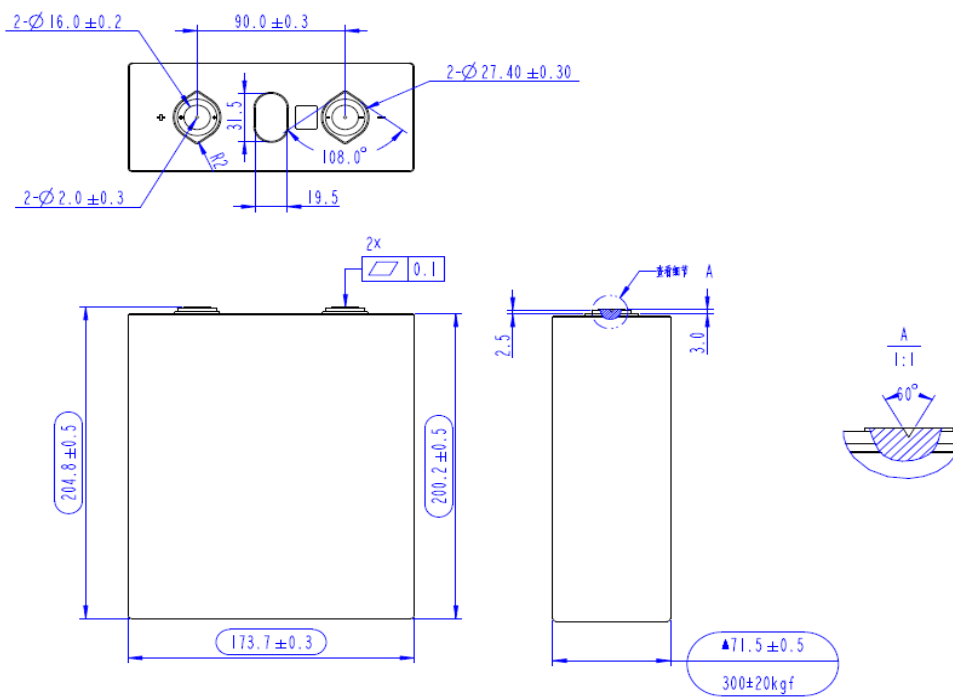



**Appendix II: Battery coding rules**

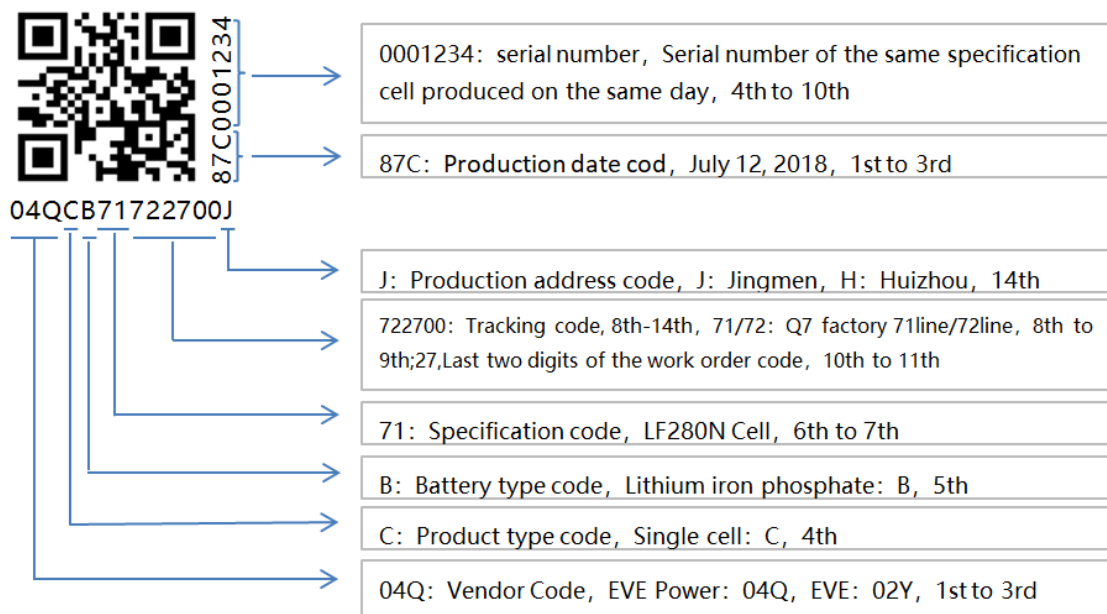

**Appendix III: Battery appearance picture**

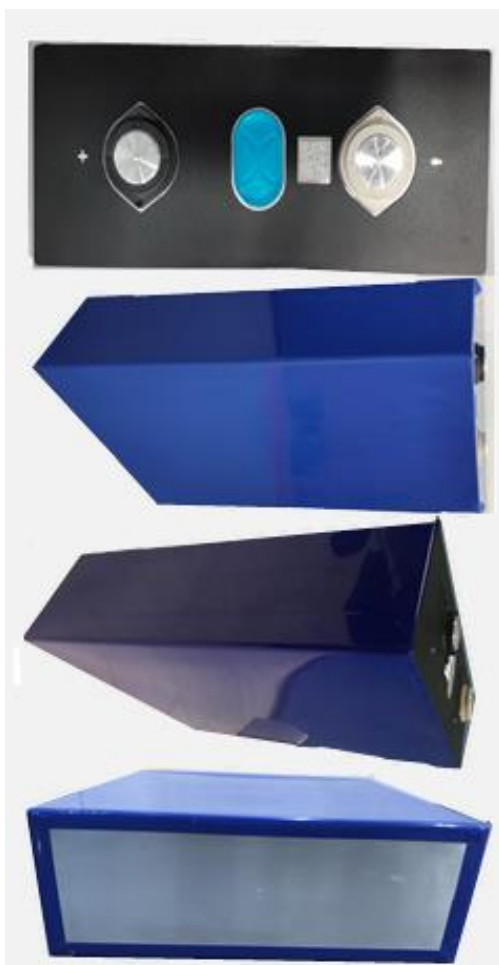

**Appendix IV: Battery Packing Diagram**

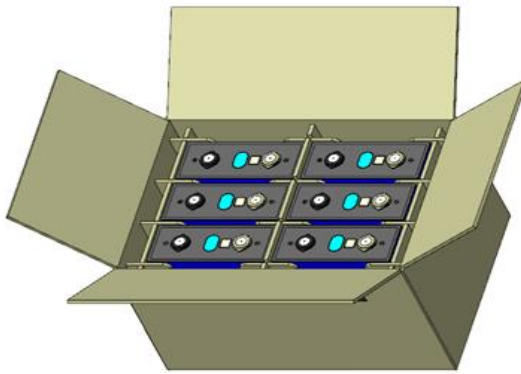

L×W×H: 426×302×245mm

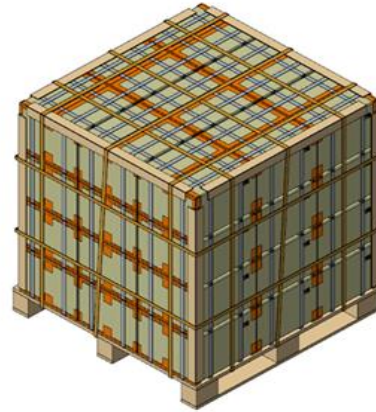

L×W×H: 1300×1100×1140mm

**Appendix V: Battery performance graph**

- 1、C-Rate Discharge Performance at 25°C    2、 Discharge performance at different temperatures e

LF280N C-Rate Discharge Performance

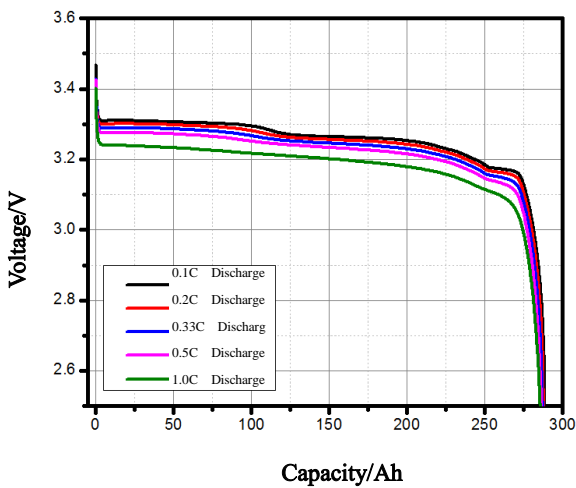

LF280N Discharge performance at different temperatures

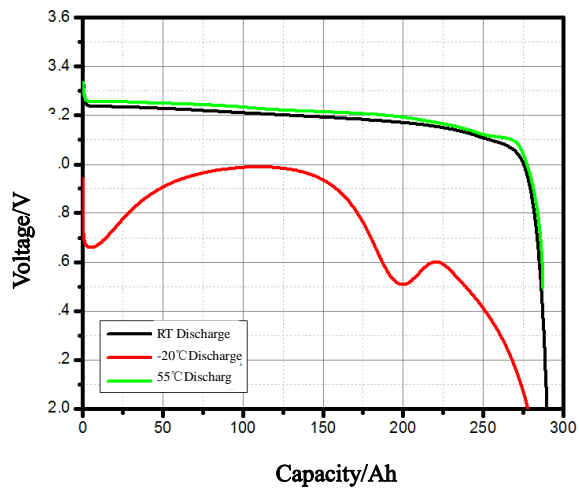

- 3、 Cycle curve(1C/1C 3.65V-2.5V)

LF280N Cycle Curve

