

1 YEAR WARRANTY

DNK

3.7V DNK795051 3020mAh LiPo Battery Pack with PCM. This datasheet describes the properties which is manufactured by DNK POWER Co. Ltd.- China.

Battery Dimension Pictures

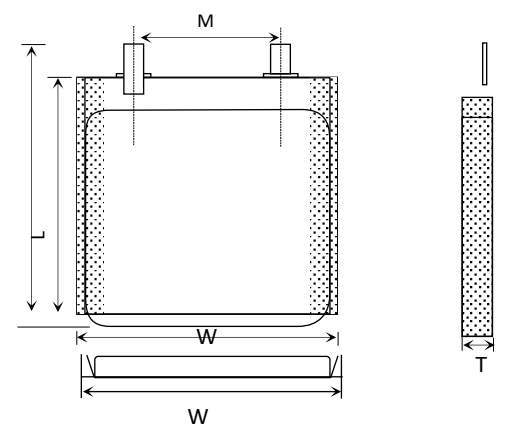

Item	Parameter (mm)
T	7.9
W	50
M	10
L	51
L ₁	53
BL	53 ± 1
CL	100

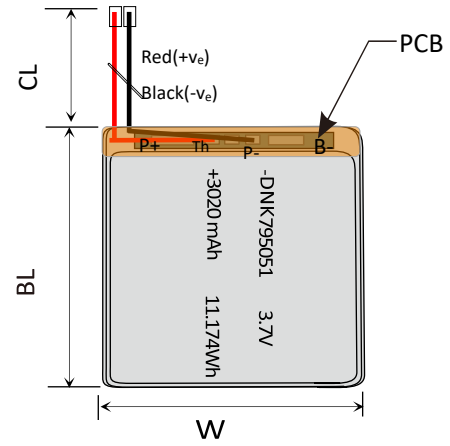

Electrical Data

Part Number	LP 795051
Nominal Voltage	3.7V
Nominal Capacity	3020 mAh
Internal Impedance	<60m Ω
Charge Voltage	4.2V
Recommended Charge Current	0.2C
Allowed Max Charge Current	0.5C
Output Voltage Range	4.2 - 2.5V
Recommend Discharge Current	0.2C
Max Continuous Discharge Current	1C
Pulse Discharge Current	3C(10mS)
Discharge Cut-off Voltage	2.5 ± 0.05V
Cycle Life to 80% Health	500(0.2C, 25°C)

Environmental Data

Charging Temperature Range	0 - 45° C
Discharge Temperature Range	-20 - 60° C
Storage Period 1 Week	-20 - 45° C
Storage Period 1 Month	-10 - 45° C
Storage Period 6 Months	0 - 35° C

Battery Protection

Over Charge	4.275 ± 50mV
Over Discharge	2.5V ± 50mV
Over Current	3A to 5A
Short Circuit	Yesv

Mechanical Data

Dimension(L ₁ +W*T)	53 x 50 x 7.9 mm
Weight	appr 50.4 g
Battery Terminals	WC/FL*

*WC=With Connector FL=Flying Leads Specifications are subject to change without notice

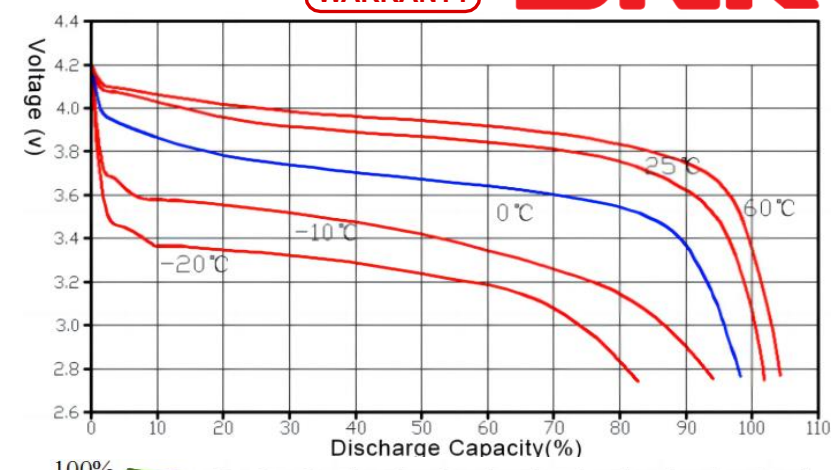

ANNOUNCEMENTS

- Do not fully discharge your LiPo battery . Discharging a LiPo beyond it's critical minimum voltage (3.0v) can cause damage to the battery.
- Ensure that charging leads are connected correctly. Reverse charging can lead to cell damage, fire or explosion.
- If you have dropped or damaged a LiPo battery in any way, do not attempt to charge it.

CONTACT INFO

Mail: sales@dnkpower.com
 Tel:+86 755 36827358 Hour of operation: 9:00am-6:00pm, Mon. to Fri.
 Mob:+86 189 4877 2006 Learn More on: <https://www.dnkpower.com/>