

# DNK

**1 YEAR  
WARRANTY**

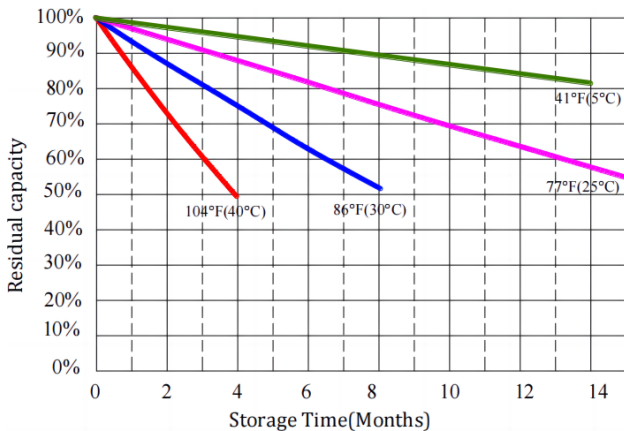

Different Temperature Discharge Curve



Different Rate Charge Curve

## ANNOUNCEMENTS

- Do not put the battery under the high temperature places (like sunshine irradiation or car in the hot weather), or it will catch fire for the heat, reduce the performance and loss the life;
- To insure the safety, the battery should install the safety device, please not use when the static electricity is more than we need when produce, or the safety device will lose efficacy and lead the overheating, fracture, exploding and catching fire;

## CONTACT INFO

Mail: sales@dnkpower.com

Tel: +86 755 36827358

Mob: +86 189 4877 2006

Hour of operation: 9:00am-6:00pm, Mon. to Fri.

Learn More on: <https://www.dnkpower.com/>

## Battery Dimension Pictures

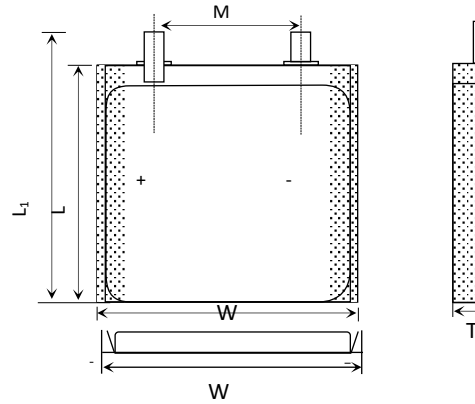

Item	Parameter (mm)
T	7.0
W	20
M	15
L	25
L <sub>1</sub>	27
BL	27 ± 1
CL	100

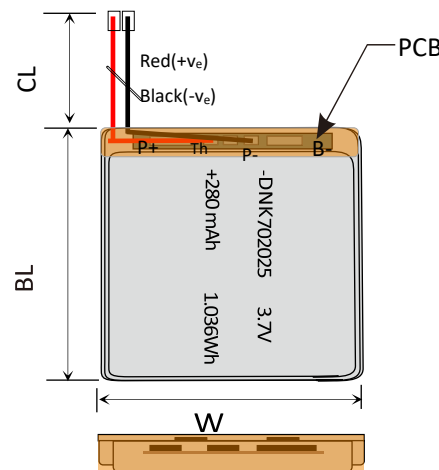

Specifications are subject to change without notice.

3.7V DNK702025 280mAh LiPo Battery Pack with PCM. This datasheet describes the properties which is manufactured by DNK POWER Co. Ltd.- China

## Electrical Data

Part Number	DNK702025
Nominal Voltage	3.7V
Nominal Capacity	280mAh
Internal Impedance	< 60mΩ
Charge Voltage	4.2V
Recommended Charge Current	0.2C
Allowed Max Charge Current	0.5C
Output Voltage Range	4.2 - 2.5V
Recommend Discharge Current	0.2C
Max Continuous Discharge Current	1C
Pulse Discharge Current	3C(10mS)
Discharge Cut-off Voltage	2.5 ± 0.05V
Cycle Life to 80% Health	500(0.2C, 25°C)

## Environmental Data

Charging Temperature Range	0 - 45°C
Discharge Temperature Range	-20 - 60°C
Storage Period 1 Week	-20 - 45°C
Storage Period 1 Month	-10 - 45°C
Storage Period 6 Months	0 - 35°C

## Battery Protection

Over Charge	4.275 ± 50mV
Over Discharge	2.5 ± 50mV
Over Current	3A - 5A
Short Circuit	Yes

## Mechanical Data

Dimension	27×20×7.0 mm
Weight	≤10g
Battery Terminals	WC/FL*

\*WC=With Connector FL=Flying Leads