

1 YEAR WARRANTY

DNK

3.7V DNK6035135 3200mAh LiPo Battery Pack with PCM.
 This datasheet describes the properties which is manufactured by DNK POWER Co. Ltd.- China.

Electrical Data

Part Number	LP 6035135
Nominal Voltage	3.7V
Nominal Capacity	3200 mAh
Internal Impedance	<60mΩ
Charge Voltage	4.2V
Recommended Charge Current	0.2C
Allowed Max Charge Current	0.5C
Output Voltage Range	4.2 - 2.5V
Recommend Discharge Current	0.2C
Max Continuous Discharge Current	1C
Pulse Discharge Current	3C(10mS)
Discharge Cut-off Voltage	2.5 ± 0.05V
Cycle Life to 80% Health	500(0.2C, 25°C)

Environmental Data

Charging Temperature Range	0 - 45° C
Discharge Temperature Range	-20 - 60° C
Storage Period 1 Week	-20 - 45° C
Storage Period 1 Month	-10 - 45° C
Storage Period 6 Months	0 - 35° C

Battery Protection

Over Charge	4.275 ± 50mV
Over Discharge	
Over Current	2.5V ± 50mV
Short Circuit	3A to 5A
	Yes

Mechanical Data

Dimension(L ₁ *W*T)	137 x 35 x 6.0 mm
Weight	appr 53.4 g
Battery Terminals	WC/FL*

Battery Dimension Pictures

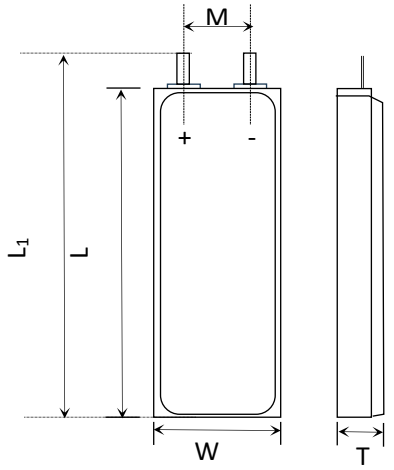

Item	Parameter (mm)
T	6.0
W	35
M	20
L	135
L ₁	137
BL	137 ± 1
CL	100

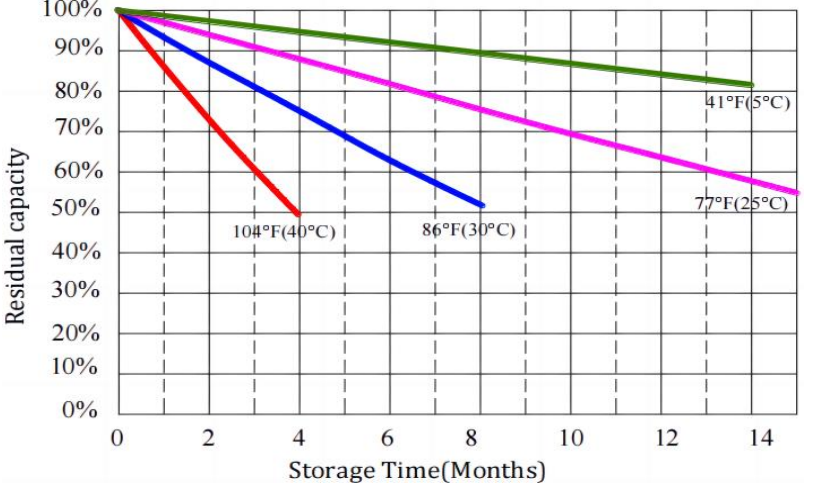
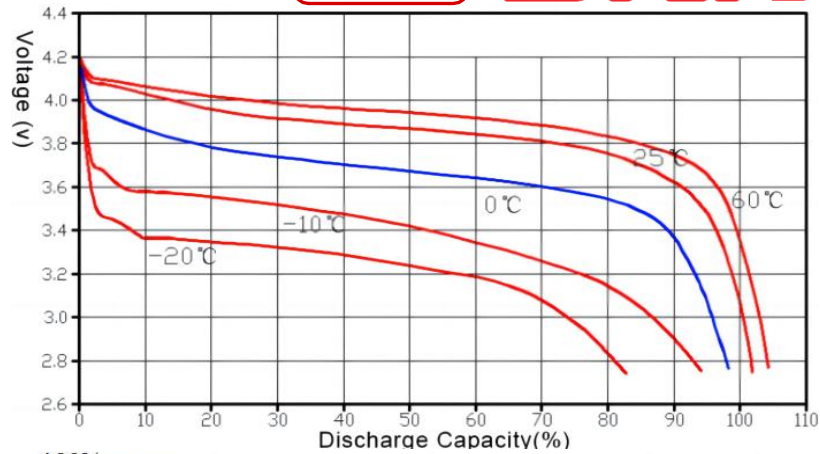
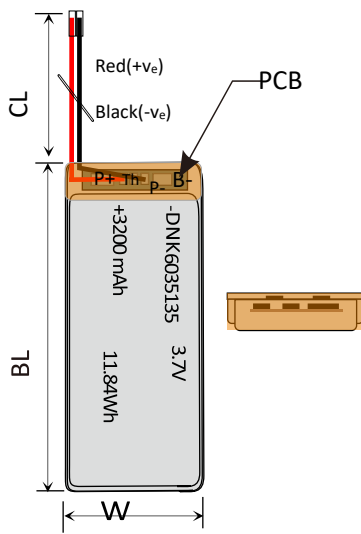

ANNOUNCEMENTS

- Do not allow reverse charging, the li-po battery should be accurately connected by polarity, can not be reversed.
- Do not allow short circuits, as this can cause permanent damage.
- The li-po battery can not be used under extreme conditions, such as: extreme temperature, deep cycle, extreme overcharge and over-discharge.
- Store the li-po battery in a cool, dry place. If a large amount of li-po battery is stored or shipped, the li-po battery must be discharged first.

CONTACT INFO

Mail: sales@dnkpower.com
 Tel:+86 755 36827358 Hour of operation: 9:00am-6:00pm, Mon. to Fri.
 Mob:+86 189 4877 2006 Learn More on: <https://www.dnkpower.com/>

*WC=With Connector FL=Flying Leads Specifications are subject to change without notice.