

DNK

**1 YEAR
WARRANTY**

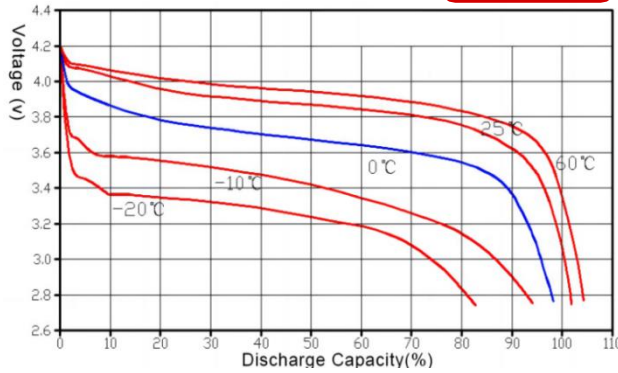

Different Temperature Discharge Curve

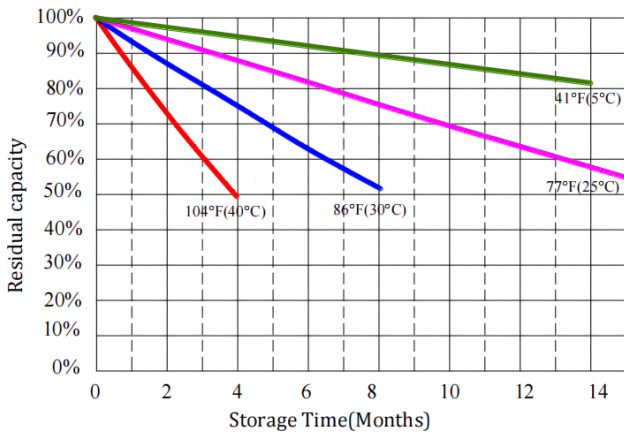

Different Rate Charge Curve

ANNOUNCEMENTS

- Do not beat or throw the battery;
- Do not impale the battery with needle or some other sharp things, do not strike it with weight;
- Do not approach the heat source, like fire or heater;
- Do not direct-connected the battery to alternating current power supply, or autoignition of the vehicle;
- Please use the appointed charger when charging

CONTACT INFO

Mail: sales@dnkpower.com

USA Phone:(+1)302 202 0599

Tel:+86 755 36827358

Hour of operation: 9:00am-6:00pm, Mon. to Fri.

Mob:+86 189 4877 2006

Learn More on: <https://www.dnkpower.com/>

Battery Dimension Pictures

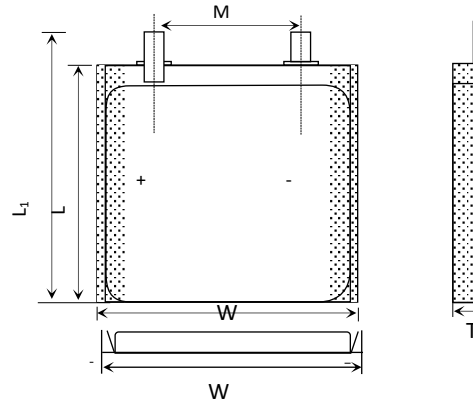

Item	Parameter (mm)
T	5.5
W	15
M	10
L	20
L ₁	22
BL	22 ± 1
CL	100

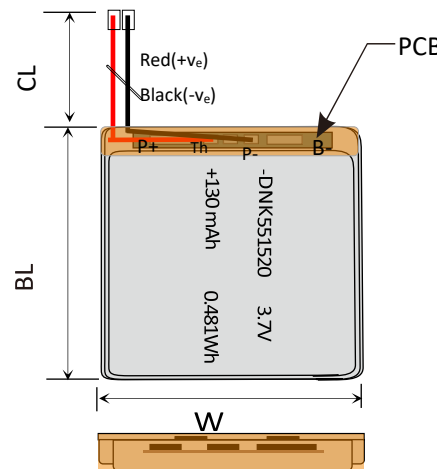

Specifications are subject to change without notice.

3.7V DNK551520 130mAh LiPo Battery Pack with PCM. This datasheet describes the properties which is manufactured by DNK POWER Co. Ltd.- China

Electrical Data

Part Number	DNK551520
Nominal Voltage	3.7V
Nominal Capacity	130mAh
Internal Impedance	< 60mΩ
Charge Voltage	4.2V
Recommended Charge Current	0.2C
Allowed Max Charge Current	0.5C
Output Voltage Range	4.2 -2.5V
Recommend Discharge Current	0.2C
Max Continuous Discharge Current	1C
Pulse Discharge Current	3C(10mS)
Discharge Cut-off Voltage	2.5 ± 0.05V
Cycle Life to 80% Health	500(0.2C, 25°C)

Environmental Data

Charging Temperature Range	0 - 45°C
Discharge Temperature Range	-20 - 60°C
Storage Period 1 Week	-20 - 45°C
Storage Period 1 Month	-10 - 45°C
Storage Period 6 Months	0 - 35°C

Battery Protection

Over Charge	4.275 ± 50mV
Over Discharge	2.5 ± 50mV
Over Current	3A - 5A
Short Circuit	Yes

Mechanical Data

Dimension	22×15×5.5 mm
Weight	≤5g
Battery Terminals	WC/FL*

*WC=With Connector FL=Flying Leads