

1 YEAR WARRANTY

DNK

3.7V DNK551140 195mAh LiPo Battery Pack with PCM. This datasheet describes the properties which is manufactured by DNK POWER Co. Ltd.- China.

Battery Dimension Pictures

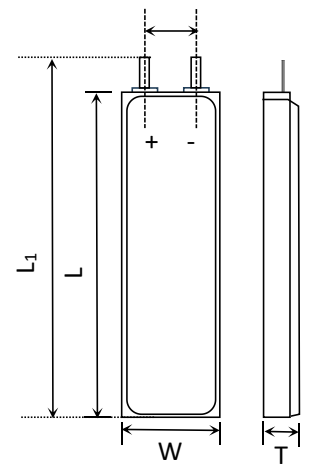

Item	Parameter (mm)
T	5.5
W	11
M	6
L	40
L1	42
BL	42 ± 1
CL	100

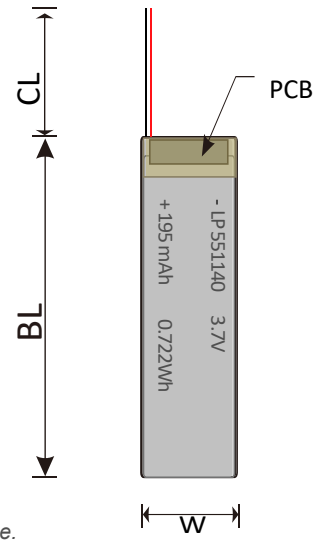

Electrical Data

Part Number	LP 551140
Nominal Voltage	3.7V
Nominal Capacity	195 mAh
Internal Impedance	< 60m Ω
Charge Voltage	4.2V
Recommended Charge Current	0.2C
Allowed Max Charge Current	0.5C
Output Voltage Range	4.2 - 2.5V
Recommend Discharge Current	0.2C
Max Continuous Discharge Current	1C
Pulse Discharge Current	3C(10mS)
Discharge Cut-off Voltage	2.5 ± 0.05V
Cycle Life to 80% Health	500(0.2C, 25°C)

Environmental Data

Charging Temperature Range	0 - 45° C
Discharge Temperature Range	-20 - 60° C
Storage Period 1 Week	-20 - 45° C
Storage Period 1 Month	-10 - 45° C
Storage Period 6 Months	0 - 35° C

Battery Protection

Over Charge	4.275 ± 50mV
Over Discharge	2.5V ± 50mV
Over Current	3A to 5A
Short Circuit	Yes

Mechanical Data

Dimension(L1+W*T)	42 x 11 x 5.5 mm
Weight	≤5 g

Battery Terminals WC/FL*
*WC=With Connector FL=Flying Leads Specifications are subject to change without notice.

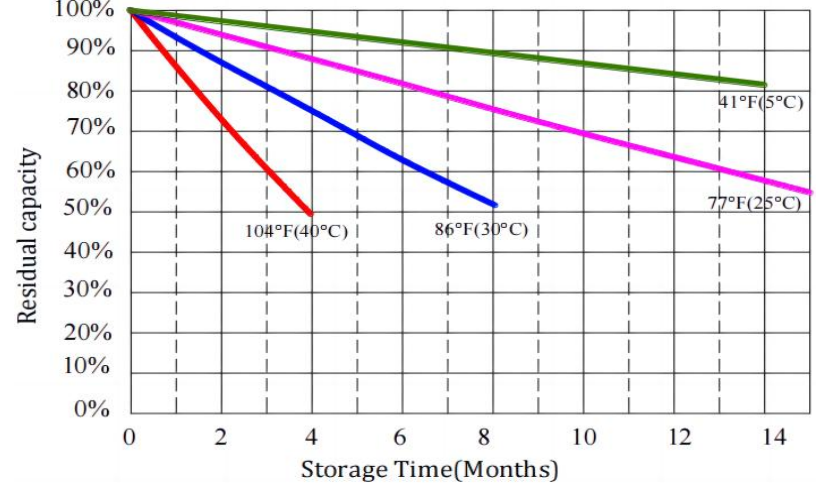
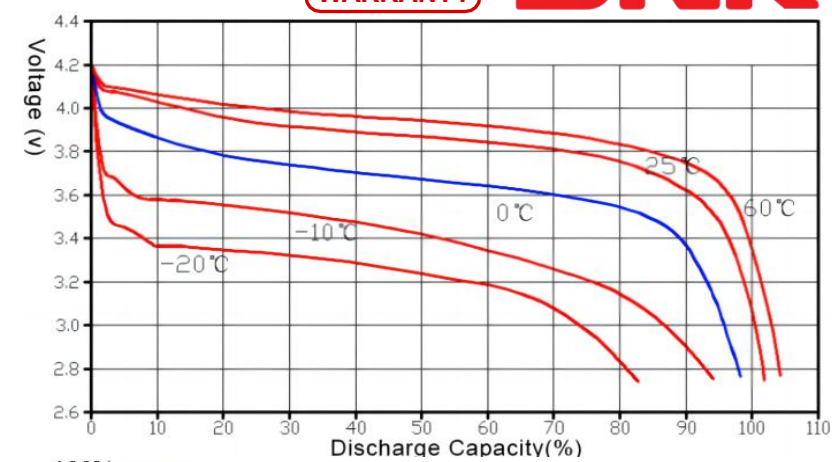

ANNOUNCEMENTS

- Ensure that charging leads are connected correctly. Reverse charging can lead to cell damage, fire or explosion.
- Never charge a LiPo pack that has ballooned or swelled due to over/under charging or from a crash.
- Never charge a lithium polymer battery pack that has been punctured or damaged in a crash.
- Do not cut the case and remove the shrink wrapped of li-po battery.

CONTACT INFO

Mail: sales@dnkpower.com
 Tel: +86 755 36827358
 Mob: +86 189 4877 2006
 Hour of operation: 9:00am-6:00pm, Mon. to Fri.
 Learn More on: <https://www.dnkpower.com/>