

1 YEAR WARRANTY

DNK

3.7V DNK4059134 4840mAh LiPo Battery Pack with PCM.
This datasheet describes the properties which is manufactured by DNK POWER Co. Ltd.- China.

Electrical Data

Part Number	LP 4059134
Nominal Voltage	3.7V
Nominal Capacity	4840 mAh
Internal Impedance	<60mΩ
Charge Voltage	4.2V
Recommended Charge Current	0.2C
Allowed Max Charge Current	0.5C
Output Voltage Range	4.2 - 2.5V
Recommend Discharge Current	0.2C
Max Continuous Discharge Current	1C
Pulse Discharge Current	3C(10mS)
Discharge Cut-off Voltage	2.5 ± 0.05V
Cycle Life to 80% Health	500(0.2C, 25°C)

Environmental Data

Charging Temperature Range	0 - 45° C
Discharge Temperature Range	-20 - 60° C
Storage Period 1 Week	-20 - 45° C
Storage Period 1 Month	-10 - 45° C
Storage Period 6 Months	0 - 35° C

Battery Protection

Over Charge	4.275 ± 50mV
Over Discharge	2.5V ± 50mV
Over Current	3A to 5A
Short Circuit	Yes

Mechanical Data

Dimension(L ₁ +W*T)	136 x 59 x 4.0 mm
Weight	appr 80.7 g
Battery Terminals	WC/FL*

Battery Dimension Pictures

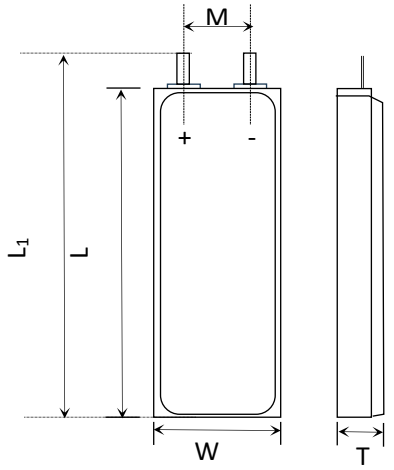

Item	Parameter (mm)
T	4.0
W	59
M	20
L	134
L ₁	136
BL	136 ± 1
CL	100

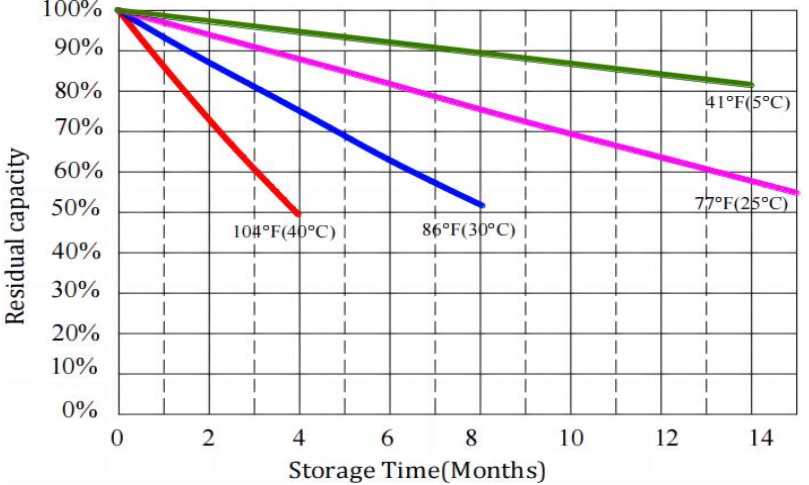
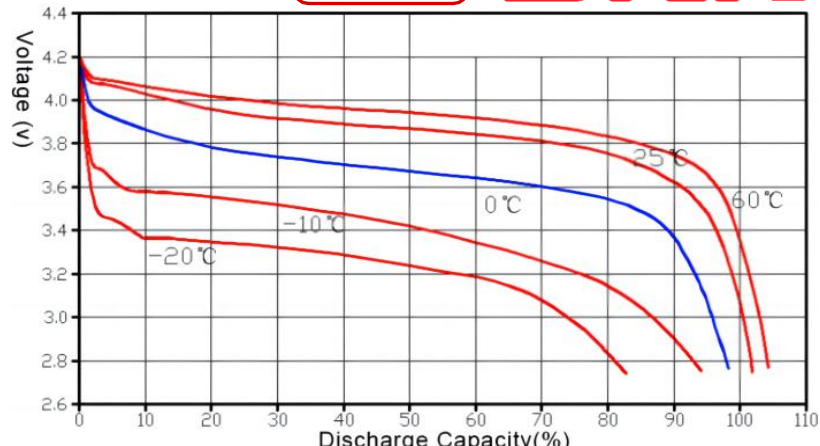
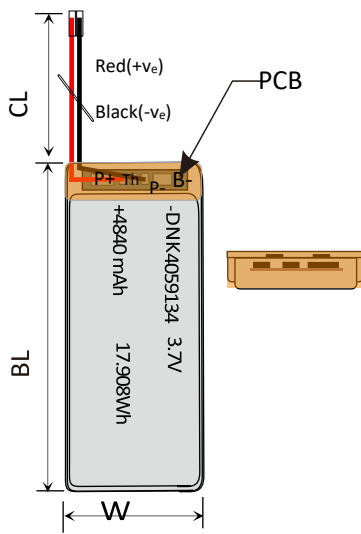

ANNOUNCEMENTS

- If you have dropped or damaged a LiPo battery in any way, do not attempt to charge it.
- Never charge a lithium polymer battery pack that has been punctured or damaged in a crash.
- Never charge a LiPo battery while it is inside your model or other electronic device.
- Never store batteries inside of an automobile.

CONTACT INFO

Mail: sales@dnkpower.com
 Tel:+86 755 36827358 Hour of operation: 9:00am-6:00pm, Mon. to Fri.
 Mob:+86 189 4877 2006 Learn More on: <https://www.dnkpower.com/>

*WC=With Connector FL=Flying Leads Specifications are subject to change without notice.