

# DNK

**1 YEAR  
WARRANTY**

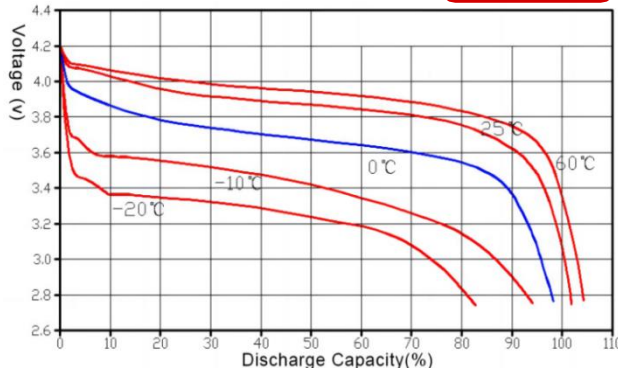

Different Temperature Discharge Curve



Different Rate Charge Curve

## ANNOUNCEMENTS

- Do not allow reverse charging, the li-po battery should be accurately connected by polarity, can not be reversed.
- Do not allow short circuits, as this can cause permanent damage.
- The li-po battery can not be used under extreme conditions, such as: extreme temperature, deep cycle, extreme overcharge and over-discharge.
- Do not solder the li-po battery directly.

## CONTACT INFO

Mail: sales@dnkpower.com

Tel:+86 755 36827358

Mob:+86 189 4877 2006

Hour of operation: 9:00am-6:00pm, Mon. to Fri.

Learn More on: <https://www.dnkpower.com/>

## Battery Dimension Pictures

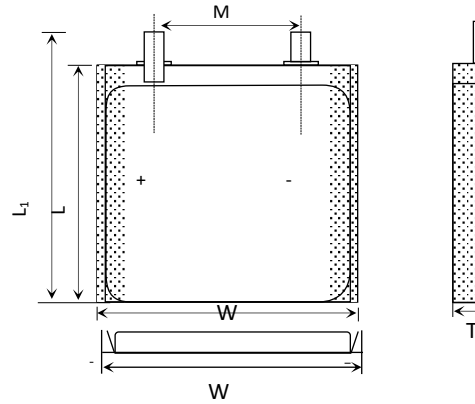

Item	Parameter (mm)
T	4.0
W	30
M	15
L	35
L <sub>1</sub>	37
BL	37 ± 1
CL	100

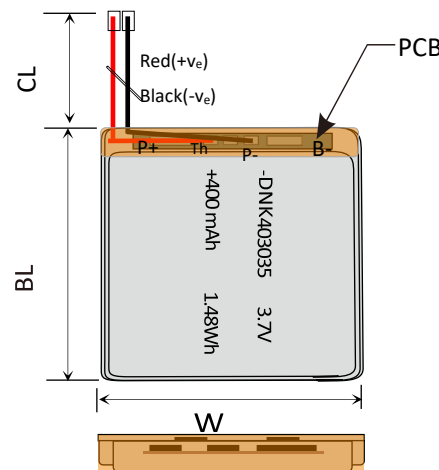

Specifications are subject to change without notice.

3.7V DNK403035 400mAh LiPo Battery Pack with PCM. This datasheet describes the properties which is manufactured by DNK POWER Co. Ltd.- China

## Electrical Data

Part Number	DNK403035
Nominal Voltage	3.7V
Nominal Capacity	400mAh
Internal Impedance	< 60mΩ
Charge Voltage	4.2V
Recommended Charge Current	0.2C
Allowed Max Charge Current	0.5C
Output Voltage Range	4.2 -2.5V
Recommend Discharge Current	0.2C
Max Continuous Discharge Current	1C
Pulse Discharge Current	3C(10mS)
Discharge Cut-off Voltage	2.5 ± 0.05V
Cycle Life to 80% Health	500(0.2C, 25°C)

## Environmental Data

Charging Temperature Range	0 - 45°C
Discharge Temperature Range	-20 - 60°C
Storage Period 1 Week	-20 - 45°C
Storage Period 1 Month	-10 - 45°C
Storage Period 6 Months	0 - 35°C

## Battery Protection

Over Charge	4.275 ± 50mV
Over Discharge	2.5 ± 50mV
Over Current	3A - 5A
Short Circuit	Yes

## Mechanical Data

Dimension	37×30×4.0 mm
Weight	≤10g
Battery Terminals	WC/FL*

\*WC=With Connector FL=Flying Leads