

**1 YEAR WARRANTY**

**DNK**

3.7V DNK331675 400mAh LiPo Battery Pack with PCM. This datasheet describes the properties which is manufactured by DNK POWER Co. Ltd.- China.

**Battery Dimension Pictures**

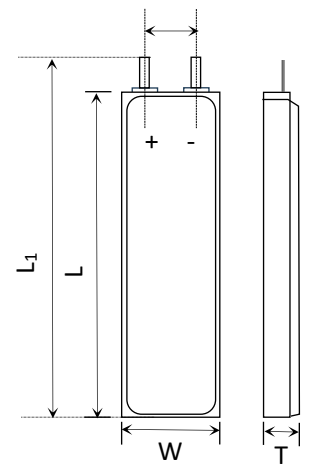

Item	Parameter (mm)
T	3.3
W	16
M	10
L	75
L <sub>1</sub>	77
BL	77 ± 1
CL	100

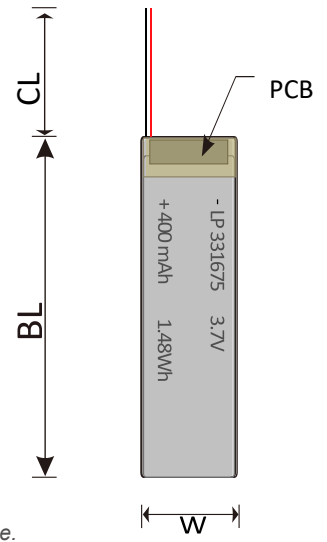

**Electrical Data**

Part Number	LP 331675
Nominal Voltage	3.7V
Nominal Capacity	400 mAh
Internal Impedance	<60m Ω
Charge Voltage	4.2V
Recommended Charge Current	0.2C
Allowed Max Charge Current	0.5C
Output Voltage Range	4.2 - 2.5V
Recommend Discharge Current	0.2C
Max Continuous Discharge Current	1C
Pulse Discharge Current	3C(10mS)
Discharge Cut-off Voltage	2.5 ± 0.05V
Cycle Life to 80% Health	500(0.2C, 25°C)

**Environmental Data**

Charging Temperature Range	0 - 45° C
Discharge Temperature Range	-20 - 60° C
Storage Period 1 Week	-20 - 45° C
Storage Period 1 Month	-10 - 45° C
Storage Period 6 Months	0 - 35° C

**Battery Protection**

Over Charge	4.275 ± 50mV
Over Discharge	2.5V ± 50mV
Over Current	3A to 5A
Short Circuit	Yes

**Mechanical Data**

Dimension(L <sub>1</sub> +W*T)	77 x 16 x 3.3 mm
Weight	≤10 g

**Battery Terminals**

WC=With Connector FL=Flying Leads Specifications are subject to change without notice.

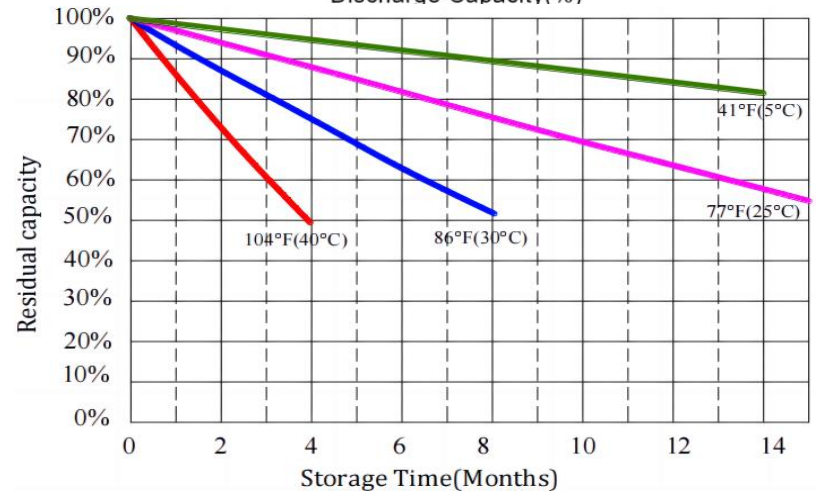
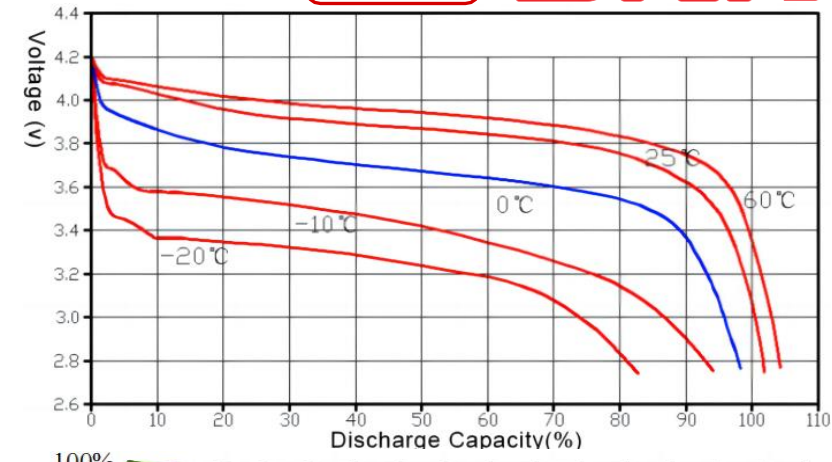

**ANNOUNCEMENTS**

- Ensure that charging leads are connected correctly. Reverse charging can lead to cell damage, fire or explosion.
- Never charge a LiPo pack that has ballooned or swelled due to over/under charging or from a crash.
- Never charge a lithium polymer battery pack that has been punctured or damaged in a crash.
- Do not cut the case and remove the shrink wrapped of li-po battery.

**CONTACT INFO**

Mail: sales@dnkpower.com

Tel:+86 755 36827358

Mob:+86 189 4877 2006

Hour of operation: 9:00am-6:00pm, Mon. to Fri.

Learn More on: <https://www.dnkpower.com/>