

**1 YEAR WARRANTY**

**DNK**

3.7V DNK3258154 3750mAh LiPo Battery Pack with PCM.  
 This datasheet describes the properties which is manufactured by DNK POWER Co. Ltd.- China.

**Electrical Data**

Part Number	LP 3258154
Nominal Voltage	3.7V
Nominal Capacity	3750 mAh
Internal Impedance	<60mΩ
Charge Voltage	4.2V
Recommended Charge Current	0.2C
Allowed Max Charge Current	0.5C
Output Voltage Range	4.2 - 2.5V
Recommend Discharge Current	0.2C
Max Continuous Discharge Current	1C
Pulse Discharge Current	3C(10mS)
Discharge Cut-off Voltage	2.5 ± 0.05V
Cycle Life to 80% Health	500(0.2C, 25°C)

**Environmental Data**

Charging Temperature Range	0 - 45° C
Discharge Temperature Range	-20 - 60° C
Storage Period 1 Week	-20 - 45° C
Storage Period 1 Month	-10 - 45° C
Storage Period 6 Months	0 - 35° C

**Battery Protection**

Over Charge	4.275 ± 50mV
Over Discharge	
Over Current	2.5V ± 50mV
Short Circuit	3A to 5A
Yes	

**Mechanical Data**

Dimension(L <sub>1</sub> *W*T)	156 x 58 x 3.2 mm
Weight	appr 62.5 g
Battery Terminals	WC/FL*

**Battery Dimension Pictures**

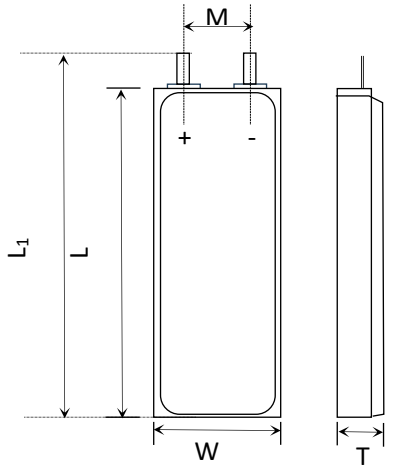

Item	Parameter (mm)
T	3.2
W	58
M	20
L	154
L <sub>1</sub>	156
BL	156 ± 1
CL	100

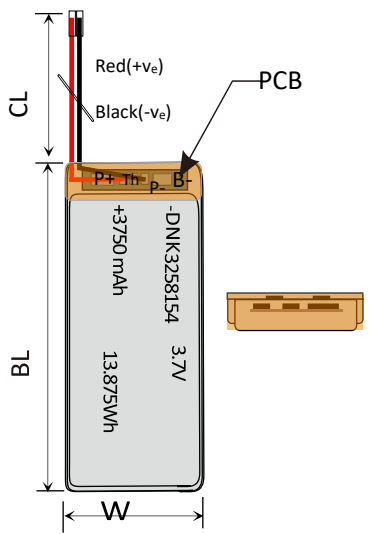

**ANNOUNCEMENTS**

- Do not allow reverse charging, the li-po battery should be accurately connected by polarity, can not be reversed.
- Do not allow short circuits, as this can cause permanent damage.
- The li-po battery can not be used under extreme conditions, such as: extreme temperature, deep cycle, extreme overcharge and over-discharge.
- Store the li-po battery in a cool, dry place. If a large amount of li-po battery is stored or shipped, the li-po battery must be discharged first.

**CONTACT INFO**

Mail: sales@dnkpower.com  
 Tel:+86 755 36827358 Hour of operation: 9:00am-6:00pm, Mon. to Fri.  
 Mob:+86 189 4877 2006 Learn More on: <https://www.dnkpower.com/>

\*WC=With Connector FL=Flying Leads Specifications are subject to change without notice